



**Low pressure
solutions**

PillAerator®

Magnetic Bearing Turbo Blowers

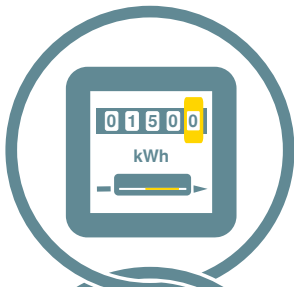
150 kW and 300 kW

Flow rate up to 267 m³/min, 16,000 m³/h, Pressure differential 0.3 to 1.3 bar

www.kaeser.com

High performance – Efficient process air

Featuring a high-speed motor, the PillAerator from KAESER is a directly coupled, oil-free compression turbo blower that provides exceptional efficiency, reliability and flexibility. The turbo impeller and motor shaft start, stop and rotate with zero wear, or the need for any need for lubrication, thanks to magnetic bearing technology. This future-forward turbo blower design is used in the low pressure range and is especially useful for applications with high flow rate and performance demands where maximum energy efficiency and process air availability are of key importance.



Energy efficient

Direct power transmission between the motor and impeller, combined with speed-controlled flow rate regulation, ensure remarkable efficiency. In addition, the wear-free magnetic bearing allows almost unlimited start/stop operation for intermittent aeration processes.



Future-forward

The motor and frequency converter are cooled by a sophisticated cooling concept, like that used in e-vehicles. The closed cooling water circuit not only protects both core components from environmental influences, but also makes their exhaust heat available for reuse.



Reliable

The magnetic bearing's intelligent sensors ensure ideal shaft position at all times. Should drastic pressure changes or voltage losses occur, the machine shuts down independently of the power supply for its own protection, so that no damage can occur.



Low noise and pulsation

With a maximum sound pressure level of 76 dB(A), the PillAerator is one of the quietest process air generators available. As turbo machines, they do not generate any pressure pulsations in the connected pipework.



Ready-to-run

The turbo blowers are designed for immediate operation with minimal installation effort. The intake air filter is already integrated and the accessories for its installation are pre-assembled. This reduces the effort required for piping and installation of ventilation ducts - especially when using the water-cooling option already included as standard.

Applications – Flexible and versatile



**TANK
AERATION**



Water management

► Aeration, flotation



**YEAST
FERMENTATION**



Food and pharmaceutical industry

► Fermentation, dispersion



AIR KNIFE



Industry

► Cooling air, combustion air
Flue gas desulphurisation

Montage uses images from: © Valenty, navinar, industrieblick - stockadobe.com



Efficient

Reliable

Low maintenance

Always the first choice for an efficient and reliable compressed air supply

Whether for use in water treatment applications, yeast production, bioreactors, for air knife applications in the steel industry, or for the purposes of flotation, turbo blowers from KAESER impress with their reliability, efficiency and exceptional ease of maintenance. Since they are completely oil-free, they are the ideal choice for sensitive processes – such as those in the food industry.

Turbo blower technology

Turbo blowers work on the principle of dynamic compression. The impeller of the radially-acting turbo compressor accelerates intake air in the circumferential direction, thereby increasing flow speed and, as a consequence, energy. Part of this energy is converted into an increase in static pressure in the downstream diffuser. With few moving components in this turbo machine, an increase in pressure with continuous flow is generated.

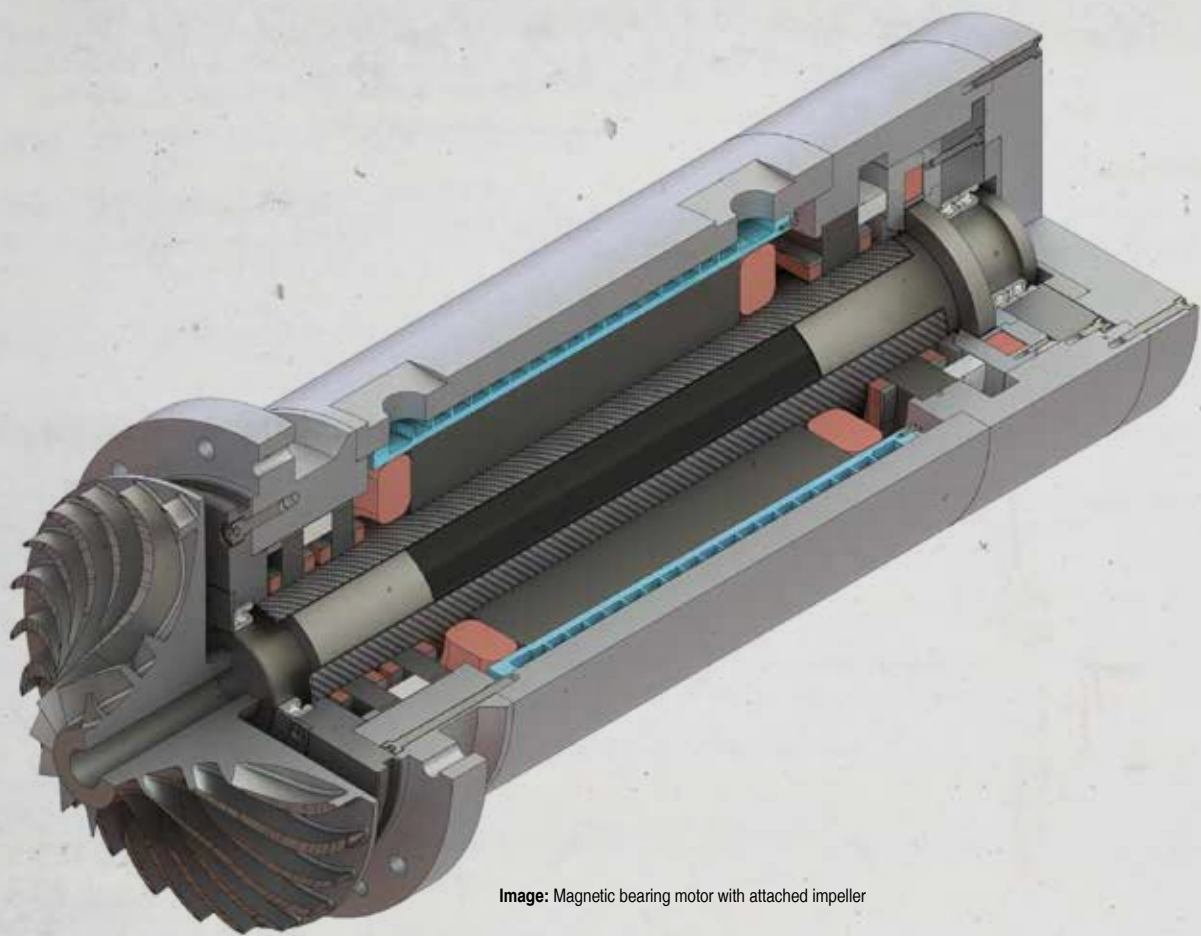


Image: Magnetic bearing motor with attached impeller

The high-speed motor

A high efficiency permanent magnet synchronous motor (PMSM) is responsible for the direct and loss-free generation of impeller speeds up to 30,000 rpm. The motor's impressive performance is made possible due to its canned motor design, whereby the stator and magnetic bearing are encapsulated from environmental influences - and without a wearing shaft seal. In order to ensure effective and controlled cooling, the motor is exclusively water-cooled, which also protects it from ingress of fine dust.

The motor shaft is levitated by a magnetic bearing that not only enables the high motor speeds to be achieved

with zero contact or wear, but also permits virtually unlimited motor starting frequency.

Furthermore, the active magnetic bearing immediately detects and compensates for deflections to keep the motor shaft safely in its rotational orbit. The magnetic bearing control device is protected against power supply failure by regenerative motor operation. In the event of unexpected, drastic pressure surges, safety bearings provide further protection for the motor shaft so that it can be brought to a controlled stop without damage.

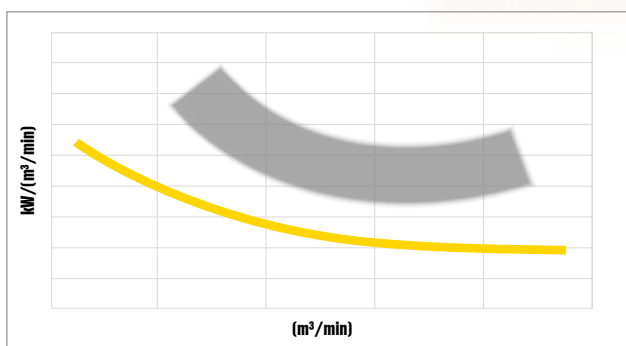
What makes the KAESER PiilAerator[®] turbo blower so special?

Rather than using conventional aviation-based air bearing technology for its turbo blowers, KAESER uses smart aeronautic magnetic bearing technology to assure uncompromising long-term availability, as is especially expected of machines in the water industry, for example.

Moreover, the PiilAerator offers significant additional advantages over other magnetic bearing blowers.

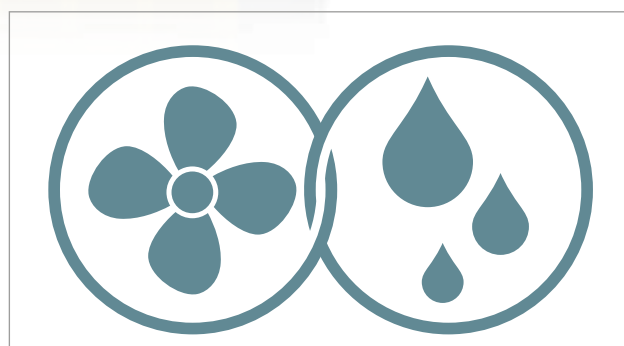


Image: KAESER PiilAerator HP 4000 turbo blower and impeller



Efficiency and control range

Different impeller versions (L, M, H) enable efficient coverage of the power and pressure range required by the specific application at hand. As shown in the graph, power consumption can therefore be reduced to a minimum (yellow line) for the required flow rate. The particular aerodynamics, which have been refined using complex flow simulations, provide a wide flow rate control range.



Cooling concept

As with modern e-vehicles, the motor and frequency converter are water-cooled and are therefore independently encapsulated from outside air. The water can be recooled either with ambient air, or with an external secondary water circuit, meaning that the heat contained in the cooling fluid can be subsequently recovered and reused.

The turbo unit – The heart of the system

The compact heart of system comprises the impeller, the turbo blower housing, the directly coupled motor, as well as the inlet nozzle and the blow-off valve. The recooling system for the motor and frequency converter cooling water is just as easily accessible and consists of air/water and water/water heat exchangers, a circulation pump and a control valve.

In order to keep sound emissions at the air inlet to an absolute minimum, the turbo blower draws in air through an integrated silencer and filter.

Dynamic drive

Made from aerospace grade aluminium alloy, the turbo impeller is seated directly on the shaft of the slim rotor. Consequently, the motor not only allows high speed operation, but also has exceptional control dynamics. For example, speeds of 20,000 rpm are achieved 5 in seconds.

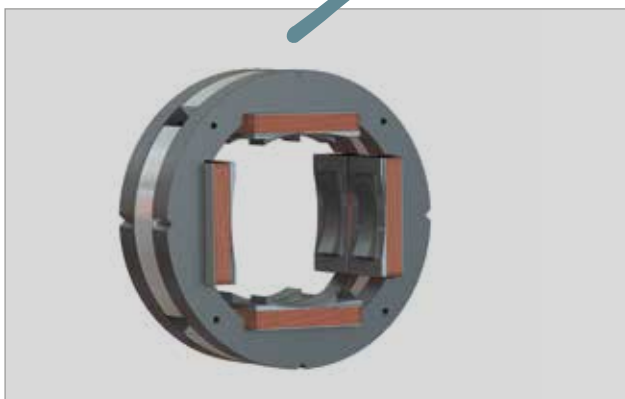
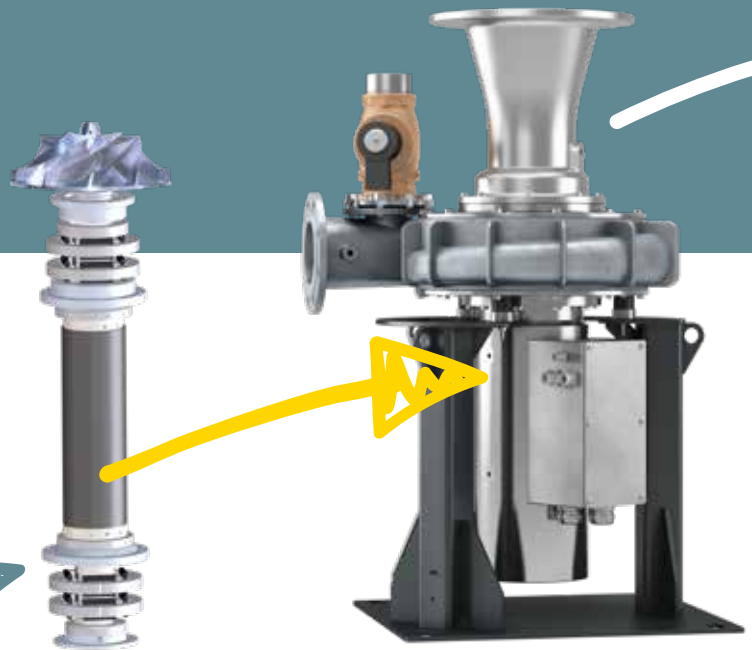


Image: © KEDA Industrial Automation Germany GmbH



Intelligent magnetic bearing technology

There is more to KAESER's magnetic bearing technology than meets the eye. The bearings are preloaded by a permanent magnetic component, which relieves their active, electromagnetic component. This consequently leads to lower winding currents and therefore to reduced heat generation.

Cooler motor

With its clever cooling concept - which is independent from ambient air conditions - and canned design, the motor not only ensures consistent cooling performance, but is also encapsulated against environmental influences. As a result, there is no need for a wear seal between the blower stage and the motor shaft.



Image: Machine layout



True flow rate

With the KAESER PillAerator, flow rate is measured in real-time at the machine inlet. The air inlet is therefore designed as a nozzle equipped with corresponding pressure and temperature sensors, to enable greater precision in delivering the required flow rate.



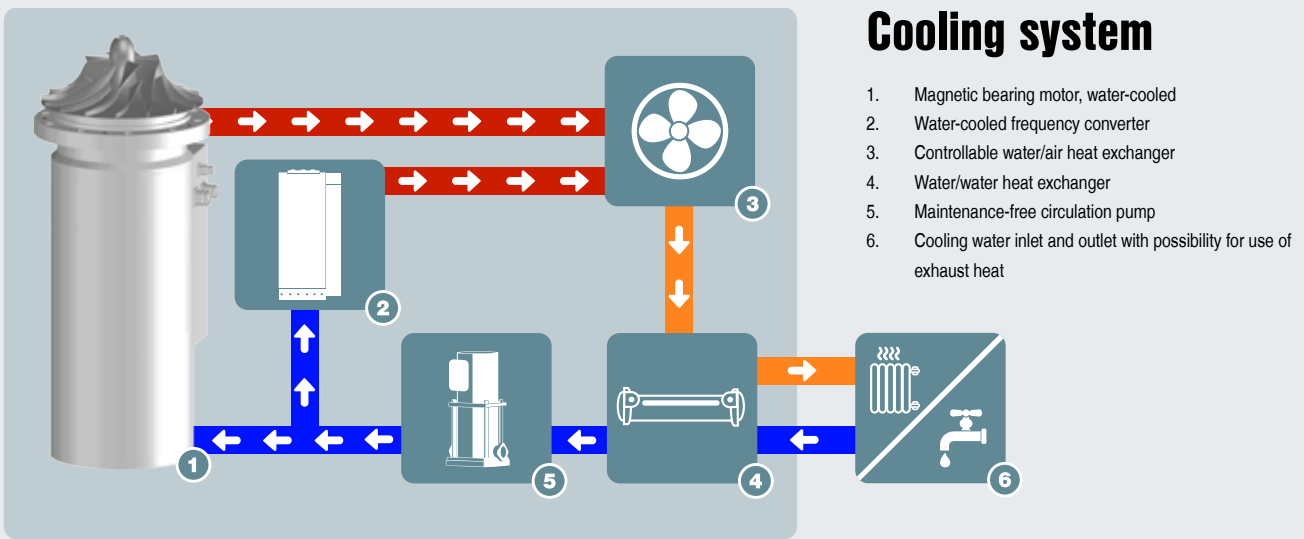
Always clean

The intake filter provides reliable protection against upstream influences such as filter breakthroughs and contaminated intake air ducts. The process air is filtered both when it is drawn in from the ambient surroundings and when it is drawn in from ducts. To ensure low life cycle costs, all filters are designed as inserts that can be changed quickly and easily.

Future-forward cooling concept

Cooling and use of exhaust heat

In a closed circuit, a pump circulates the cooling fluid via the motor and frequency converter, as well as via water/air and water/water heat exchangers. Up to a certain ambient temperature, it is possible to select either automatically or directly whether air or external cooling water should be used as the primary cooling medium. Water is the best choice for higher ambient temperatures, or for heat recovery purposes.



Water/air heat exchanger

The heat exchanger fan operates automatically depending on ambient conditions and cooling requirement. The controller also decides when the water/water heat exchanger is activated to provide additional support if necessary. It is also possible to select which option is used as the primary cooling system.



Water/water heat exchanger

This heat exchanger can be used to provide additional support at high ambient temperatures, or can be selected as the primary cooling system. It is designed as a hybrid heat exchanger, so that exhaust heat from the motor and frequency converter can be transferred as effectively as possible should heat recovery be required.

Exhaust heat utilisation

Save money with heat recovery

The state-of-the-art cooling circuit design is the same as that used in today's advanced e-vehicles. It protects the core components, ensures their effective cooling and enables utilisation of recyclable exhaust heat. In a closed circuit, cooling fluid circulates via the motor and frequency converter, as well as via water/air and water/water heat exchangers. Whether used for higher ambient temperatures or with heat recovery in mind, water is the primary coolant.

Cooling mode selection explained:

Primary coolant mode: Air = Direct space heating using warm air flow. Primary coolant mode: Water = Heat transfer via the medium of water with temperatures up to approx. 40 °C.

Advantage: The heat from the drive section is always available – with the same temperature level, regardless of the season (in contrast to heat exchangers in the pressure line).



Directly usable heat – guaranteed!

On average, approx. 6 % heat output occurs in modern turbo blowers in the drive section, comprising the motor and its control technology. With good use of the machine, this equates to between 6 and 12 kW for medium-sized turbo blowers (150 kW series) and 15 to 20 kW for large turbo blowers (300 kW series).

When multiplied by the number of blowers in operation, this results in an impressive amount of potentially directly usable heat energy.

Potential heat use:

- Usable for processes: Heating biology or bioreactors, sludge conditioning and drying.
- Usable for buildings: Low-temperature surface heating or support for the heating circuit, feed into a heat pump to achieve a higher temperature level (service water or similar).

Equivalence to familiar energy sources and CO₂ emissions

The exhaust heat from the drive trains of three turbo blowers (each with a power consumption of 160 kW) corresponds to a heating value of 15,000 to 25,000 litres of heating oil per year, depending on load. That consequently translates into an annual CO₂ emission of 44 to 73 tons – these figures are doubled for 300 kW series machines.



Importance of the coolant for air-conditioning



AIR-cooled operation

Air-cooled blower station operation

When selecting the preferred coolant – air or water, or both in combination – it is important to consider the compressed air system as a whole.

This especially applies to exclusively air-cooled turbo stations with process air intake via supply air ducting, and supply and exhaust air openings for machine room ventilation. The lower the temperature difference between the outside environment and the inside of the machine room, the stronger the room ventilation needs to be, which can often present a challenge, particularly in existing buildings.

In such cases, water offers an attractive alternative as the cooling medium.





WATER- cooled operation

Water-cooled blower station operation

In water-cooled operation, the effort required for room ventilation and cooling is significantly lower, both in terms of supply air and exhaust air. Exhaust air ducting can even be omitted entirely, since most of the exhaust heat from the machine can be removed from the room using water. The water piping shown below the pressure pipework is sufficient to achieve this.

Since the preferred cooling medium can be switched over via the KAESER turbo blower, warm exhaust air can be used in winter, for example, to provide room heating or to preheat the intake process air via bypass flaps.



Electronics



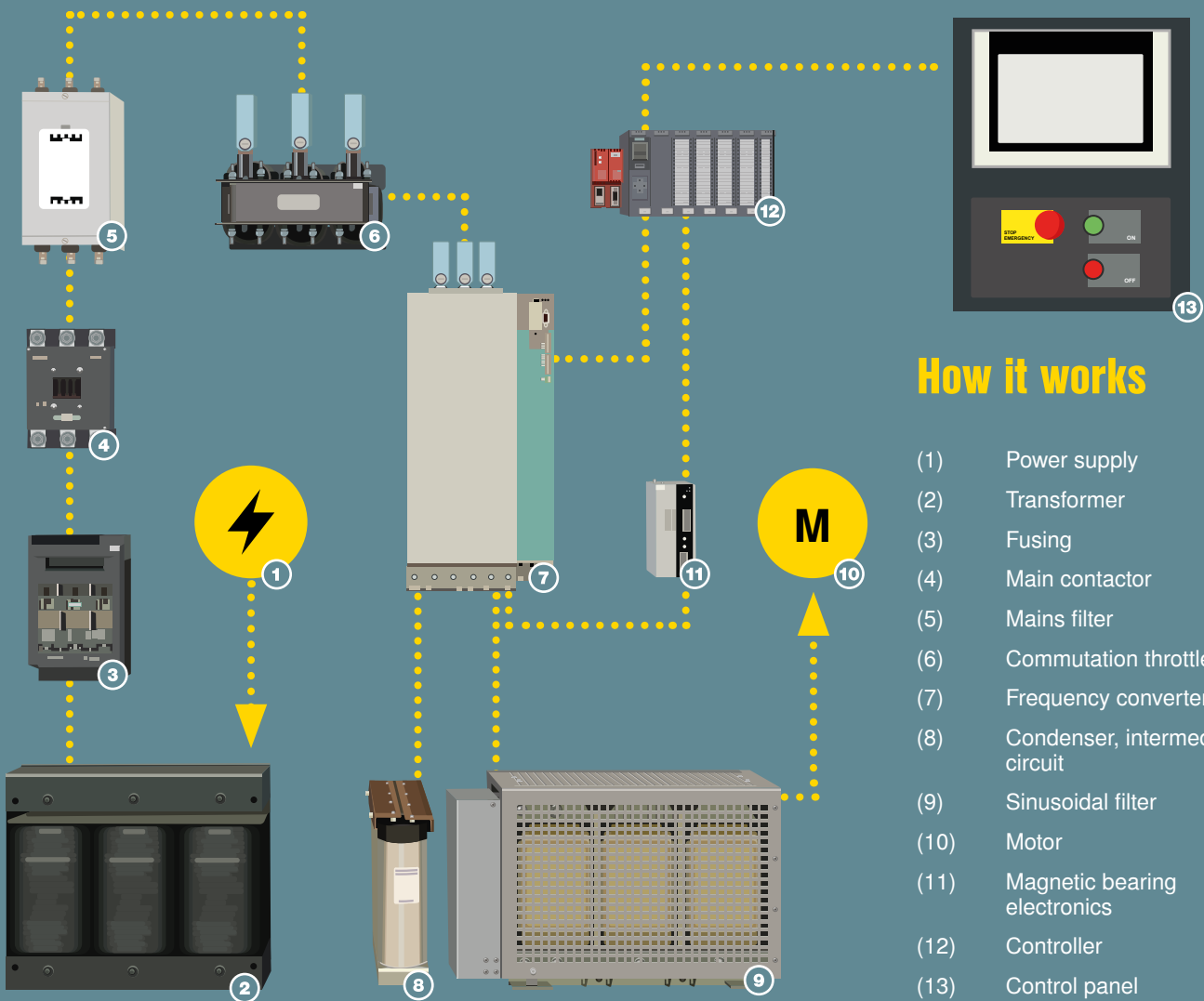
User interface (HMI)

All performance and operating states can be displayed on the 9" colour touch panel and users can choose from over 20 selectable interface languages. If remote control capability is not available from the control centre, or if an associated fault occurs, the machine can be operated with manual setpoint input (flow rate, pressure or external process variables).



Data centre

All other systems, such as the frequency converter, are coordinated via the powerful central processing unit connected to the HMI. This bundles the flow of information via the HMI and the programmable controller.



How it works

- (1) Power supply
- (2) Transformer
- (3) Fusing
- (4) Main contactor
- (5) Mains filter
- (6) Commutation throttle
- (7) Frequency converter
- (8) Condenser, intermediate circuit
- (9) Sinusoidal filter
- (10) Motor
- (11) Magnetic bearing electronics
- (12) Controller
- (13) Control panel



Frequency conversion

The speeds required for the high-speed motor are generated via a powerful frequency converter, which enables variable-speed operation and therefore continuous flow rate adjustment to meet actual demand. The closed water cooling circuit ensures consistent frequency converter performance.



Safety concept

In the event of a power failure, the machine is shut down and comes to a controlled stop. Meanwhile, the power supply for the magnetic bearing control unit is generated by the motor and frequency converter. This eliminates the need for batteries or UPS packages and their associated maintenance.

EVERYTHING AT A GLANCE

and under control

- ✓ Speed and flow rate
- ✓ Pressures and temperatures
- ✓ Operating and maintenance hours
- ✓ System and status data
- ✓ Warning and fault messages
- ✓ Communication



Operating data

The operating point is displayed in the turbo blower's characteristic map in real-time. Machine utilisation and distance to operating limits can therefore be immediately seen at glance. Messages are displayed on the screen, are accessible at the press of a button and are archived as a message history. Relevant process data and messages are also stored to SD card and can be analysed later as required.



Status data

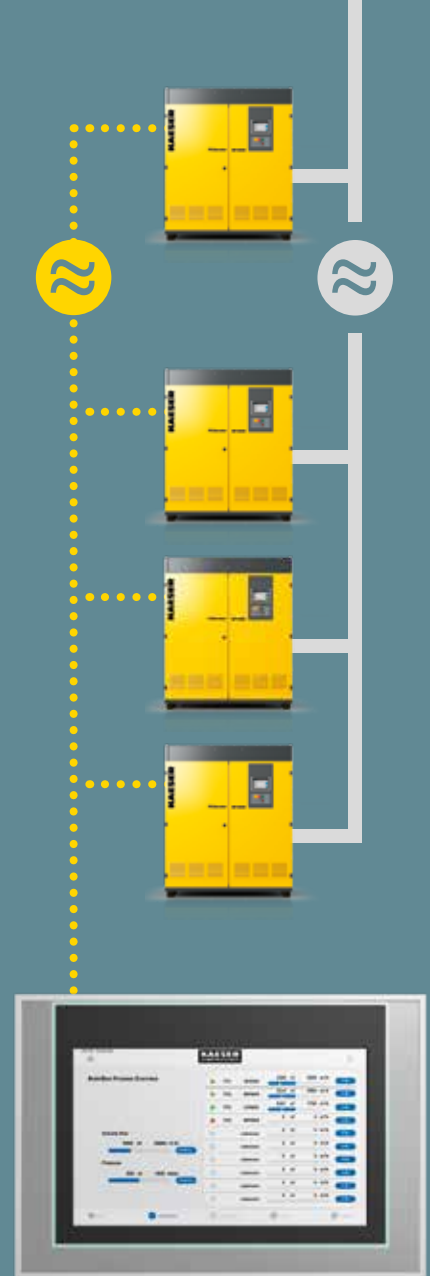
The main components of the turbo blower are shown clearly and unambiguously as a P+I diagram, from which their operating and status data can be read immediately. This includes the components through which the process air flows, those of the cooling circuit, the motor (rotor position and magnetic bearing temperature) and the frequency converter (voltage, current and temperature).



Image: © by-studio - Fotolia

Remote control from a control centre

Modbus TCP, EtherNet/IP, Profinet and Profibus DP, each with a comprehensive process image, are available for communication and remote control via data bus connection. The machine operating limits are also communicated via these technologies to safeguard control. Alternatively, the machine can be controlled via analogue and digital interfaces.

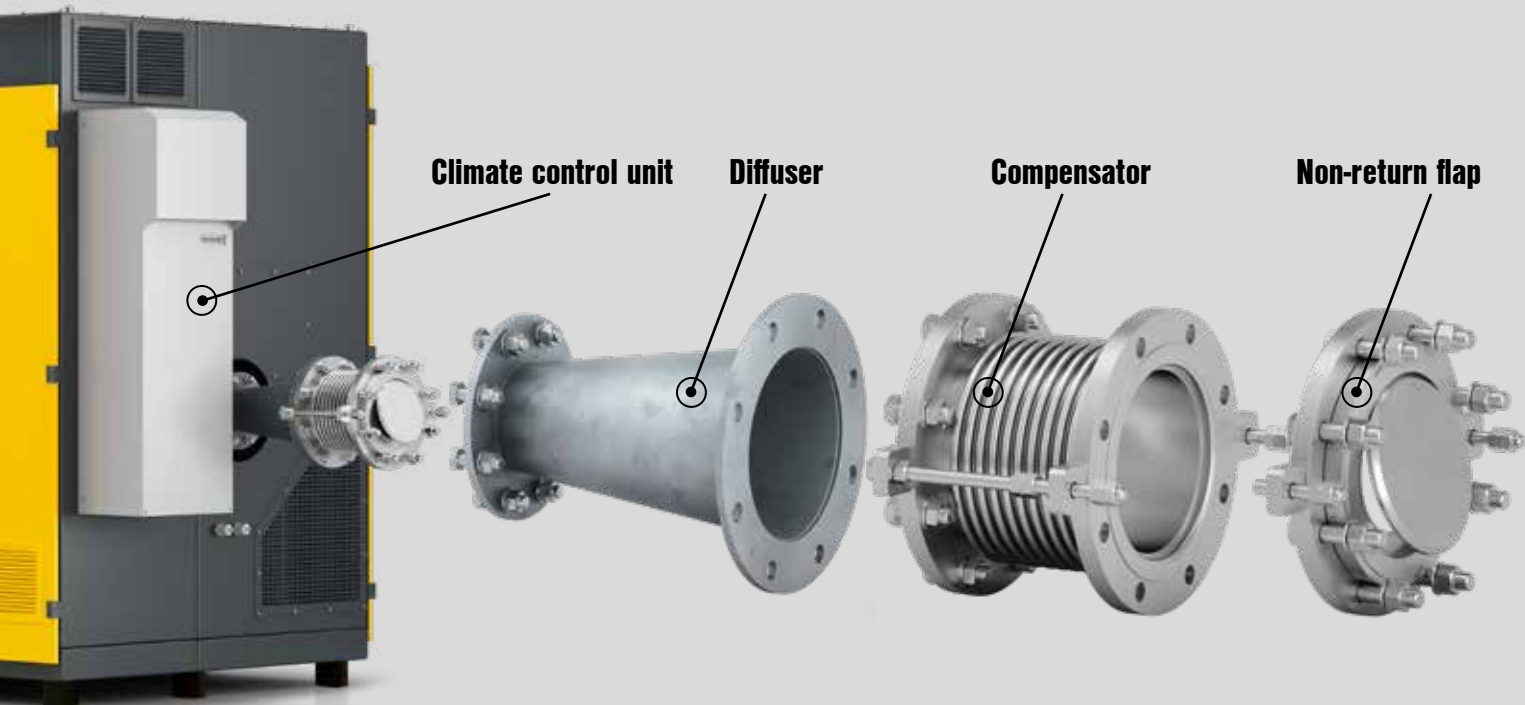


Master controller

A master controller is available for connection of up to 10 turbo blowers. In 'Flow rate' or 'Pressure control' operating mode, the master controller coordinates efficient operation of the individual machines within the blower station, as well as their switching processes. In addition, the controller's bus protocol not only delivers the current process data, but also the status data of the individual machines to the master control centre. PROFIBUS, PROFINET, Modbus TCP and EtherNet/IP are available for communication.

Accessories and options

Your needs – Our solutions

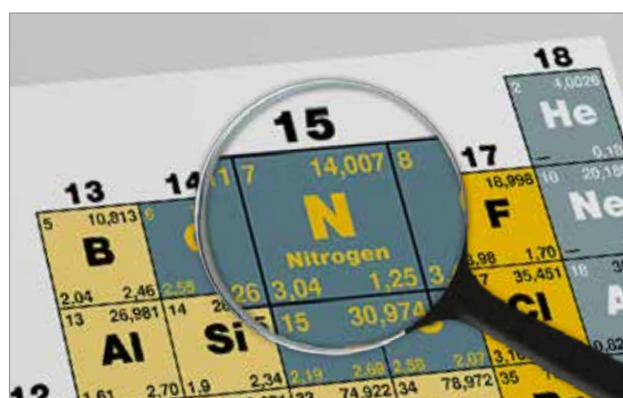


The add-on parts are available to fit DIN and ANSI flanges, the diffusers are also offered as 90° versions. Pipe silencers are also available upon request.



Control cabinet climate control

The optional climate control unit for control cabinet cooling enable turbo blower operation in ambient temperatures up to 45°C (300 kW series) and even 55°C (150 kW series), as long as the drive section is also supplied with sufficient cooling water. The climate control units are thermally controlled, the cooling air in the control cabinet is decoupled from the environment.

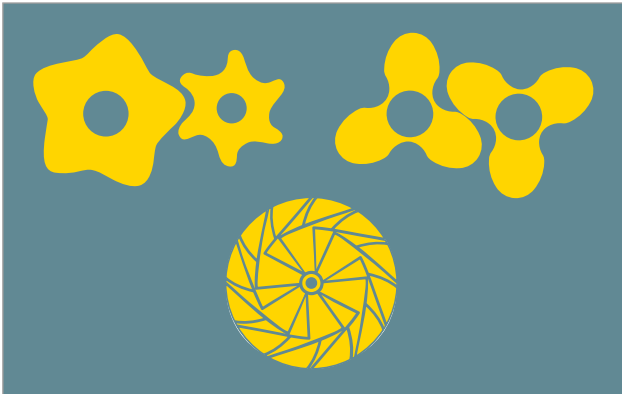


Nitrogen variants – Nitrogen version

A special version of the 150 kW turbo blower is available for conveying of the inert gas nitrogen, e.g. for air knife applications in the steel industry. With this version, the suction-side process line can be connected directly. The turbo blower's exceptional control dynamics are highly valued for this purpose.

System solutions from KAESER

Since you generally require complete system solutions to meet your industrial process needs, rather than individual components, KAESER is the perfect partner for you. Our philosophy is to provide reliable and efficient holistic solutions that go beyond machine and control technology. This starts with expert planning and continues with customer focus and ready availability of service parts to keep your process running safely and efficiently at all times.



Technological expertise

As a leading manufacturer of rotary lobe, screw and turbo blowers, KAESER is always able to advise which technology is right for your specific application. Function and efficiency require correct coordination of the process needs with the properties of the particular blower technology.



Service/After-sales

No machine is 100 % maintenance-free. In order to keep key processes running smoothly, you need an efficient partner with a comprehensive service network.



Expert planning

The road to an efficient and effective system begins with expert planning. KAESER is there with you every step of the way to provide professional support, starting with initial system analysis through to complete station design.

Assembly



Production

Highest possible vertical integration of mechanical and electrical components at the KAESER factory guarantees consistent quality and seamless interaction of every individual part.



Assembly

“Made in Germany” represents the very highest standards with regards to component manufacture and assembly in accordance with stringent quality regulations. This not only includes hardware components, but also software.



Quality assurance

Prior to delivery, each blower is subjected to an intensive factory test run. Performance data are checked and documented and core components are serialised. This ensures correct functionality and guarantees traceability.

Technical specifications



150 KW

Model	Permissible working pressure	Flow rate ¹⁾ Complete system at working pressure	Flow rate ¹⁾ Complete system at working pressure	Maximum sound pressure level ²⁾	Weight
	bar	m ³ /min	m ³ /h		
HP 4000	0.4 – 1.4	17 – 88	1,000 – 5,300	74	1815
MP 6000	0.3 – 1.2	22 – 113	1,300 – 6,800	75	1815
LP 8000	0.3 – 1.0	25 – 128	1,500 – 7,700	76	1815

Speed:
30,000 rpm

Dimensions WxDxH [mm]:
1800 x 1525 x 2125

Comp. air connection ³⁾:
DN250/PN10



300 KW

Model	Permissible working pressure	Flow rate ¹⁾ Complete system at working pressure	Flow rate ¹⁾ Complete system at working pressure	Maximum sound pressure level ²⁾	Weight
	bar	m ³ /min	m ³ /h		
HP 9000	0.4 – 1.3	47 – 180	2,800 – 10,800	75	3785
MP 12000	0.3 – 1.2	52 – 227	3,100 – 13,600	75	3785
LP 14000	0.3 – 1.0	73 – 263	4,400 – 15,800	75	3785

Speed:
22,000 rpm

Dimensions WxDxH [mm]:
2930 x 2125 x 2155

Comp. air connection ³⁾:
DN400/PN10

- ¹⁾ Pressure differential and flow rate, complete system as per ISO 5389:2005: absolute inlet pressure 1 bar (a), cooling and air inlet temperature +20 °C
²⁾ Sound pressure level as per ISO 2151 and basic standard ISO 9614-2, tolerance: ± 3 dB (A) – dependent upon operating point
³⁾ Compressed air connection (with add-on diffuser)

Performance ranges

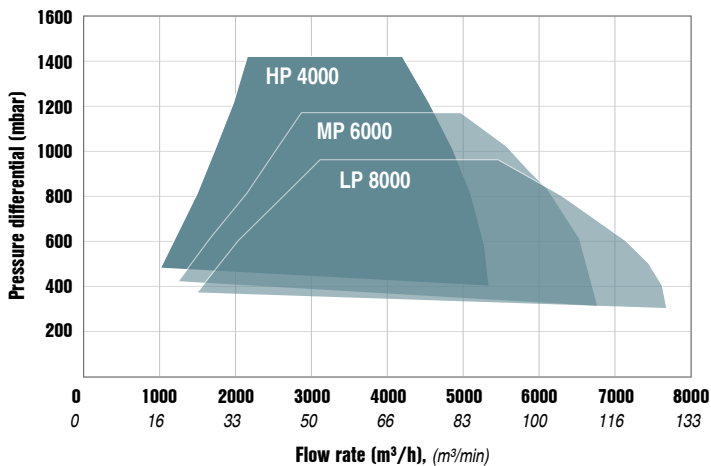


Image: Characteristic map for 150 kW series

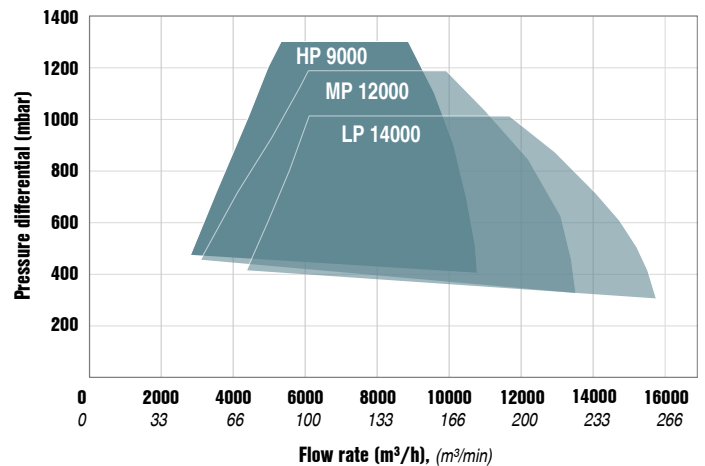


Image: Characteristic map for 300 kW series

The world is our home

As one of the world's largest manufacturers of compressors, blowers and compressed air systems, KAESER KOMPRESSOREN is represented throughout the world by a comprehensive network of branches, subsidiaries and authorised distribution partners in over 140 countries.

By offering innovative, efficient and reliable products and services, KAESER KOMPRESSOREN's experienced consultants and engineers work in close partnership with customers to enhance their competitive edge and to develop progressive system concepts that continuously push the boundaries of performance and technology. Moreover, decades of knowledge and expertise from this industry-leading systems provider are made available to each and every customer via the KAESER group's advanced global IT network.

These advantages, coupled with KAESER's worldwide service organisation, ensure that every product operates at peak performance at all times, whilst providing maximum availability.



KAESER COMPRESSORS Australia Pty. Ltd.

Locked Bag 1406 – Dandenong South – Vic. 3164
45 Zenith Road – Dandenong – Vic. 3175
Phone: +61 39791 5999 – Fax: +61 39791 5733
www.kaeser.com – E-mail: info.australia@kaeser.com

KAESER COMPRESSORS NZ Limited

PO BOX 301261 – Albany – Auckland 0752
18B Tarnsdale Grove – Albany – Auckland 0632
Phone +64 9 941 0499
www.kaeser.com – E-mail: info.newzealand@kaeser.com